

19 - 020 (1,230 kg/m)

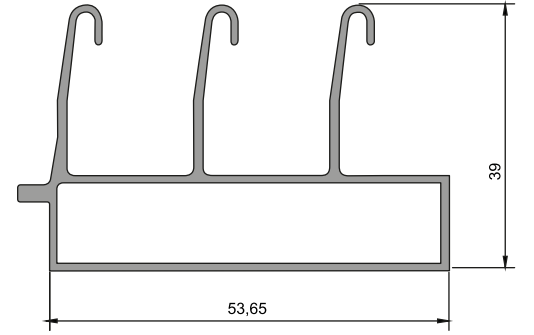

19 - 021 (0,745 kg/m)

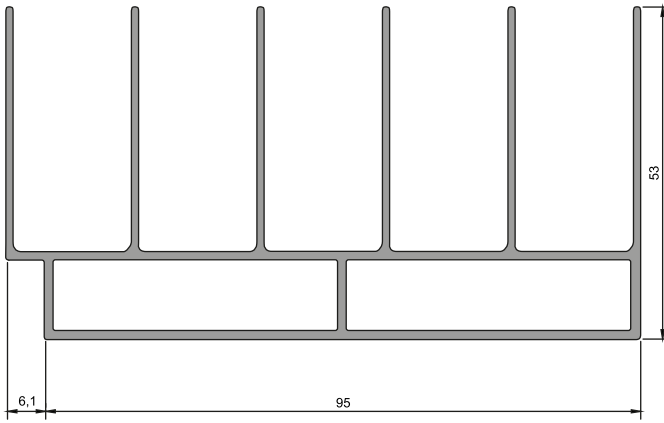

19 - 024 (1,575 kg/m)

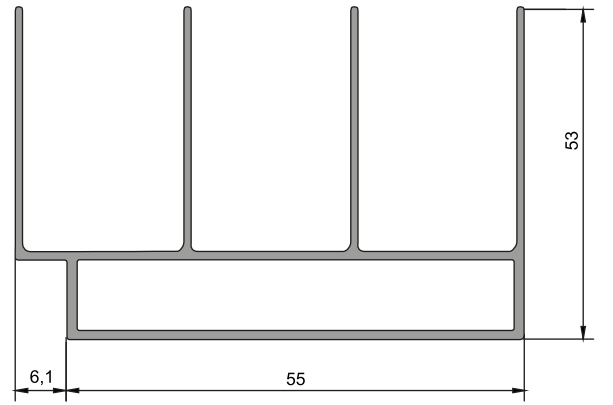

19 - 025 (0,995 kg/m)

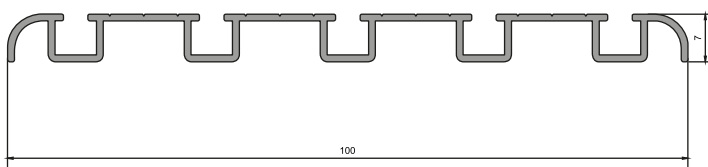

19 - 022 (0,482 kg/m)

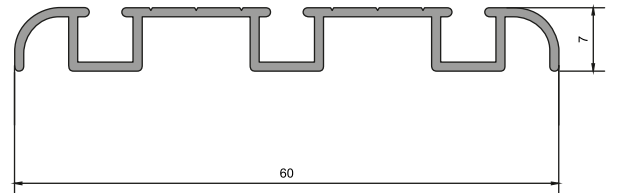

19 - 023 (0,298 kg/m)

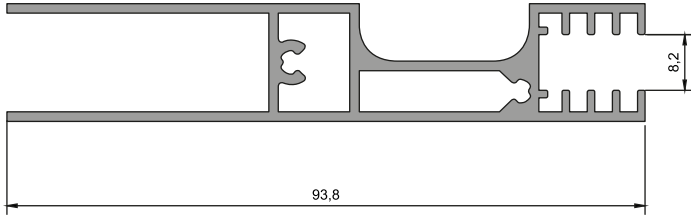

19 - 026 (1,045 kg/m)

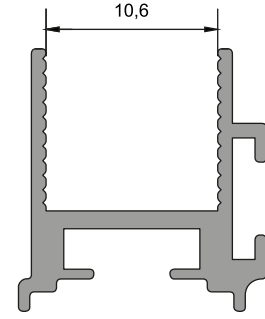

19 - 028 (0,155 kg/m)

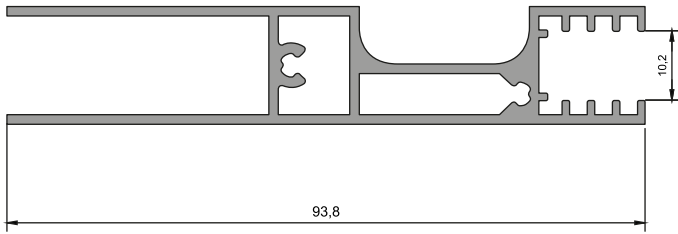

19 - 027 (1,033 kg/m)

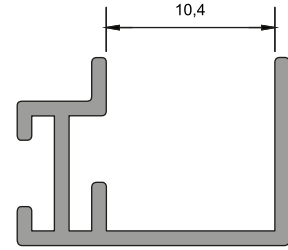

19 - 029 (0,119 kg/m)

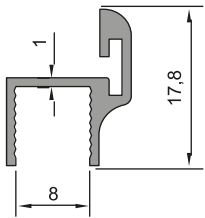

19 - 011 (0,144 kg/m)

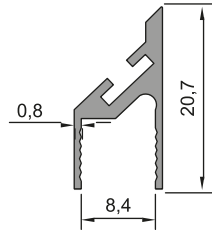

19 - 012 (0,141 kg/m)

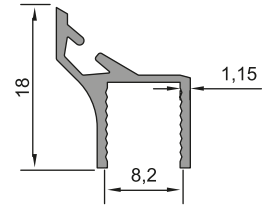

19 - 013 (0,136 kg/m)

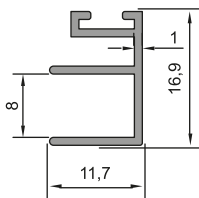

19 - 014 (0,138 kg/m)

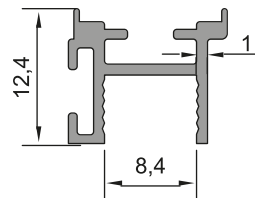

19 - 015 (0,127 kg/m)

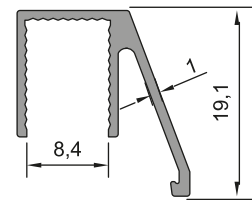

19 - 016 (0,152 kg/m)