

Alüminyum profiller AlMgSi 0,5 - F22 alaşımından ve 12020 Standartlarına göre üretilir.

Fiziksel Özellikler :

1- Yoğunluk	: 2,71 gr / cm ³
2- Elastisite Modülü	: 70 kN /mm ²
3- Direnç	: 20° 33 n Ω .m
4- Erime Noktası	: 600 - 655 °
5 - Genleşme Katsayısı:	20 - 100° C μ °C ⁻¹

Mekanik Özellikler :

1- Elastisite Limiti	: 190 MPa
2 - Kopma dayanıklılığı	: 220 MPa
3- Sertlik	: 67 Brinell
4- Uzama	: % 10

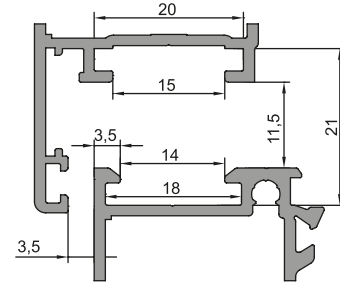

EURO KANAL TİP 1

SİSTEM BİLGİLERİ :

Profil Genişlik : Kasa 55mm - Kanat 63mm

Conta Sistemi : Üç Conta sistemli

Fitil (Conta) : Tüm fitiller Kaucuk Özellikli EPDM dir.

Yapılabilir Pencere Tipleri : İçe açılır - Çift açılır - Çift Kanat açılır - Volkswagen Pencere - Pivot pencere tipleri ile İçe açılır Kapı - Dışa açılı Kapılar.



Kullanılabilir Cam Kalınlığı : 4m Tek cam dan 34mm Isı cam kalınlığına kadar EPDM fitil kalınlıkları ve ölçüsüne uygun cam çitası ile ayarlanak istenilen ısı cam kullanım imkanı sunmaktadır.

Su Tahliye : Bütün Profiller Su tahliye sistemine sahiptir.

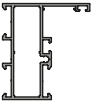
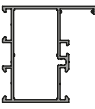
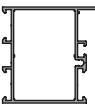
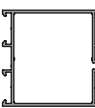
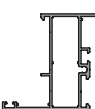
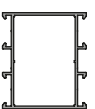
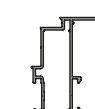
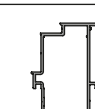
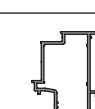
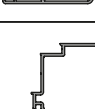
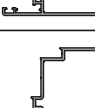
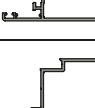
Bağlantılar : Köşe birleşimlerini sağlamak için Pres Köşe takoz bağlantıları ve Çene L parçaları kullanılarak preslenir. Orta Kayıtlar dışarıdan vidaatılarak ve iç kısımdan takozları ile bağlanır.

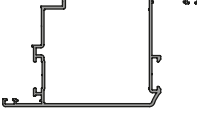
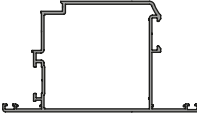
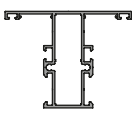
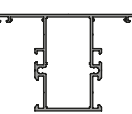
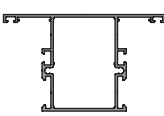
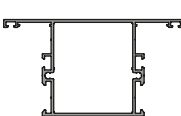
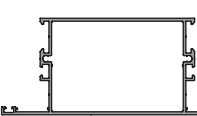
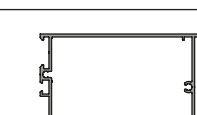
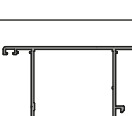
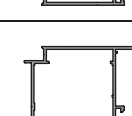
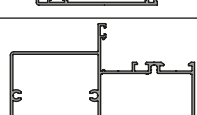
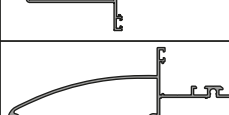
Profil Şekli Profile Drawing	Profil Tanımı Profile Description	Profil Kodu Profile Code	Profil Ağırlığı Profile Weight (Kg/m)	Statik Değer Static Value (Ix - Iy cm ⁴)	Köşe Bağlantı Kodu Corner Connection Code	Köşe Bağlantı Ölçüsü Corner Connection Size
	Kasa Profili 1,5 mm	20 - 001	0,905 Kg/m	Jx : 13,55 cm ⁴ Jy : 4,49 cm ⁴	21- 044	51,6 mm
	Kasa Profili 1,5 mm	20 - 002	0,986 Kg/m	Jx : 16,26 cm ⁴ Jy : 8,34 cm ⁴	21- 045	51,6 mm
	Kasa Profili 1,5 mm	20 - 003	1,068 Kg/m	Jx : 19,88 cm ⁴ Jy : 13,08 cm ⁴	21- 046	51,6 mm
	Kasa Profili 2,0 mm	20 - 043	1,344 Kg/m			
	Kasa Profili 1,5 mm	20 - 004	1,208 Kg/m	Jx : 27,10 cm ⁴ Jy : 18,07 cm ⁴	21- 048	51,4 mm
	Kasa Profili 1,5 mm	20 - 005	0,980 Kg/m	Jx : 18,92 cm ⁴ Jy : 5,43 cm ⁴	21- 044	51,6 mm
	Kasa Ortakayıt Profili 1,5 mm	20 - 006	0,930 Kg/m	Jx : 14,72 cm ⁴ Jy : 10,22 cm ⁴	21- 045	51,6 mm
	Kanat Profili 1,5 mm	20 - 007	1,005 Kg/m	Jx : 22,63 cm ⁴ Jy : 4,58 cm ⁴	21- 044	53,9 mm
	Kanat Profili 1,5 mm	20 - 008	1,085 Kg/m	Jx : 27,07 cm ⁴ Jy : 8,27 cm ⁴	21- 045	53,9 mm
	Kanat Profili 2,0 mm	20 - 044	1,374 Kg/m			
	Kanat Profili 1,5 mm	20 - 009	1,166 Kg/m	Jx : 27,15 cm ⁴ Jy : 8,37 cm ⁴	21- 045 21- 047	24,8 mm 28,8 mm
	Kanat Profili 1,5 mm	20 - 010	1,228 Kg/m	Jx : 33,84 cm ⁴ Jy : 13,56 cm ⁴	21- 046	53,7 mm
	Kanat Profili 1,5 mm	20 - 011	1,314 Kg/m	Jx : 41,31 cm ⁴ Jy : 18,96 cm ⁴	21- 048	53,7 mm
	Kanat Profili 1,5 mm	20 - 012	1,314 Kg/m	Jx : 31,02 cm ⁴ Jy : 27,54 cm ⁴	21- 048	53,7 mm

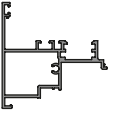
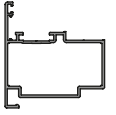
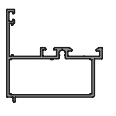
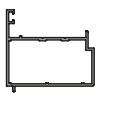
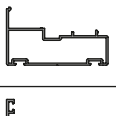
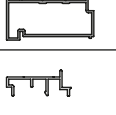
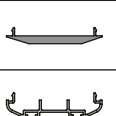
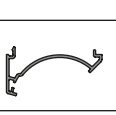
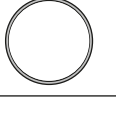
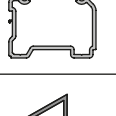
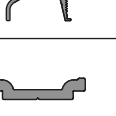
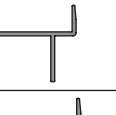
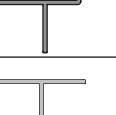
Profil Şekli	Profil Tanımı	Profil Kodu	Profil Ağırlığı	Statik Değer	Köşe Bağlantı Kodu	Köşe Bağlantı Ölçüsü
Profile Drawing	Profile Description	Profile Code	Profile Weight (Kg/m)	Static Value (Ix - Iy cm ⁴)	Corner Connection Code	Corner Connection Size
	Kanat Profil 1,5 mm	20 - 013	1,490 Kg/m	Jx : 59,01 cm ⁴	21- 050	53,5 mm
	Kanat Profil 2,0 mm	20 - 045	1,753 Kg/m	Jy : 27,62 cm ⁴		
	Kanat Profil 1,5 mm	20 - 014	1,490 Kg/m	Jx : 51,13 cm ⁴	21- 050	53,5 mm
	Kanat Profil 2,0 mm	20 - 046	1,753 Kg/m	Jy : 33,89 cm ⁴		
	Ortakayıt Profil 1,5 mm	20 - 015	1,045 Kg/m	Jx : 14,88 cm ⁴ Jy : 08,95 cm ⁴	21- 044	51,6 mm
	Ortakayıt Profil 1,5 mm	20 - 016	1,125 Kg/m	Jx : 17,10 cm ⁴ Jy : 14,86 cm ⁴	21- 045	51,6 mm
	Ortakayıt Profil 1,5 mm	20 - 017	1,206 Kg/m	Jx : 22,85 cm ⁴	21- 046	51,6 mm
	Ortakayıt Profil 2,0 mm	20 - 047	1,507 Kg/m	Jy : 19,31 cm ⁴		
	Ortakayıt Profil 1,5 mm	20 - 018	1,350 Kg/m	Jx : 34,14 cm ⁴ Jy : 22,58 cm ⁴	21- 048	51,4 mm
	Ortakayıt Profil 1,5 mm	20 - 019	1,661 Kg/m	Jx : 83,20 cm ⁴ Jy : 30,82 cm ⁴		
	Etek Profil 1,5 mm	20 - 020	1,735 Kg/m	Jx : 97,08 cm ⁴ Jy : 33,70 cm ⁴		
	Kanat Profil 1,5 mm	20 - 021	1,170 Kg/m	Jx : 25,05 cm ⁴ Jy : 20,42 cm ⁴	21- 048	43,4 mm
	Kanat Profil 1,5 mm	20 - 022	1,173 Kg/m	Jx : 30,83 cm ⁴ Jy : 15,52 cm ⁴	21- 048	43,4 mm
	Ortakayıt Profil 1,5 mm	20 - 023	1,800 Kg/m	Jx : 70,58 cm ⁴ Jy : 24,90 cm ⁴	21- 045	51,6 mm
	Ortakayıt Profil 1,5 mm	20 - 024	1,955 Kg/m	Jx : 118,94 cm ⁴ Jy : 24,57 cm ⁴	21- 045	51,6 mm

Profil Şekli Profile Drawing	Profil Kodu Profile Code	Profil Ağırlığı Profile Weight (Kg/m)	Statik Değer Static Value (Ix - Iy cm4)	Köşe Bağlantı Kodu Corner Connection Code	Köşe Bağlantı Ölçüsü Corner Connection Size
	20 - 025	0,986 Kg/m	Jx : 12,69 cm4 Jy : 06,96 cm4		
	20 - 026	0,958 Kg/m	Jx : 15,65 cm4 Jy : 09,23 cm4	21- 045	53,9 mm
	20 - 027	0,835 Kg/m	Jx : 11,82 cm4 Jy : 05,15 cm4		
	20 - 028	0,705 Kg/m	Jx : 09,56 cm4 Jy : 04,35 cm4		
	20 - 029	0,614 Kg/m			
	20 - 030	0,642 Kg/m	Jx : 07,94 cm4 Jy : 02,61 cm4		
	20 - 031	0,273 Kg/m			
	20 - 032	0,570 Kg/m			
	20 - 033	0,343 Kg/m			
	20 - 034	0,444 Kg/m			
	04 - 001	0,719 Kg/m			
	20 - 039	0,850 Kg/m			
	20 - 037	0,228 Kg/m			
	20 - 038	0,130 Kg/m			
	20 - 035	0,186 Kg/m			
	20 - 036	0,186 Kg/m			
	02 - 004	0,192 Kg/m			

Profil Çizimi Profile Drawing	Profil Tanımı Profile Description	Profil Kodu Profile Code	Profil Ağırlığı Profile Weight (Kg/m)
	Çıta Profili	21 - 033	0,350 Kg/m
	Glazing Bead Profile		
	Çıta Profili	21 - 034	0,335 Kg/m
	Glazing Bead Profile		
	Çıta Profili	21 - 035	0,312 Kg/m
	Glazing Bead Profile		
	Çıta Profili	21 - 036	0,295 Kg/m
	Glazing Bead Profile		
	Çıta Profili	21 - 037	0,278 Kg/m
	Glazing Bead Profile		
	Çıta Profili	21 - 038	0,247 Kg/m
	Glazing Bead Profile		
	Çıta Profili	20 - 040	0,200 Kg/m
	Glazing Bead Profile		
	Dış Cam Fitali Outer Glazing Gasket	A - 03	0,041 Kg/m
	İç Cam Fitali Inner Acoustic Gasket	A - 01	0,032 Kg/m
	İç Cam Fitali	A - 02	0,020 Kg/m
	Outer Acoustic Gasket		
	Orta Fitali	A - 04	0,098 Kg/m
	Medium Gasket		
	İç Cam Fitali Inner Glazing Gasket	A - 05	0,061 Kg/m
	İç Cam Fitali Inner Glazing Gasket	A - 06	0,073 Kg/m
	İç Cam Fitali Inner Glazing Gasket	A - 07	0,061 Kg/m
	İç Cam Fitali Inner Glazing Gasket	A - 09	0,050 Kg/m
	İç Cam Fitali Inner Glazing Gasket	A - 08	0,047 Kg/m

Profil Çizimi Profile Drawing	Profil Kodu Corner Connection Code	Profil Ağırlığı Profile Weight (Kg/m)
	21 - 044	3,030 Kg/m
	21 - 045	3,566 Kg/m
	21 - 046	4,157 Kg/m
	21 - 047	3,220 Kg/m
	21 - 048	5,307 Kg/m
	21 - 049	3,150 Kg/m
	21 - 050	6,370 Kg/m

55'LİK YALITIMSIZ SİSTEM CAM TABLOSU

4mm - A-05
5mm - A-06
6mm - A-07

21-033 (0,350 kg/m)

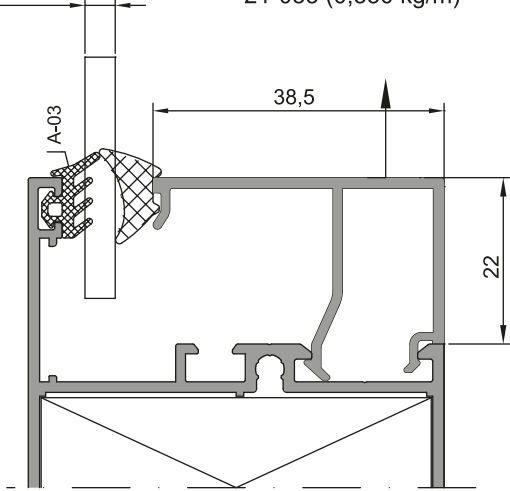

8mm - A-05
10mm - A-07

21-034 (0,335 kg/m)

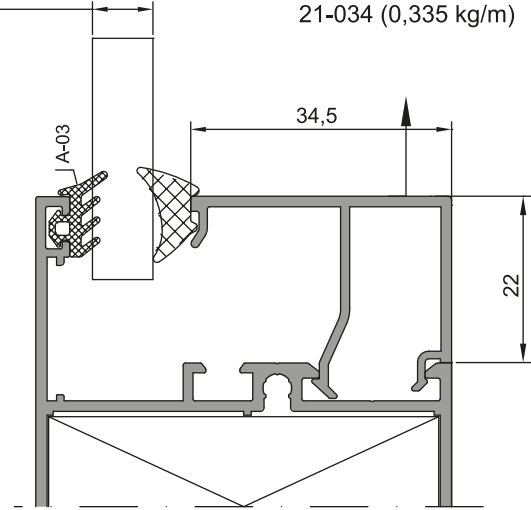

15mm - A-06
16mm - A-07
17mm - A-08

21-035 (0,312 kg/m)

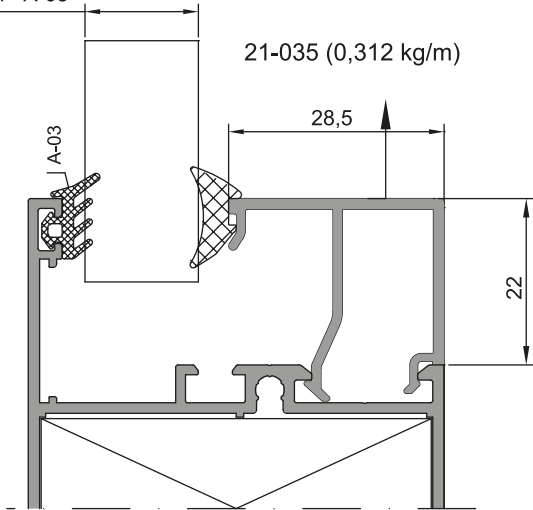

20mm - A-06
22mm - A-08

21-036 (0,295 kg/m)

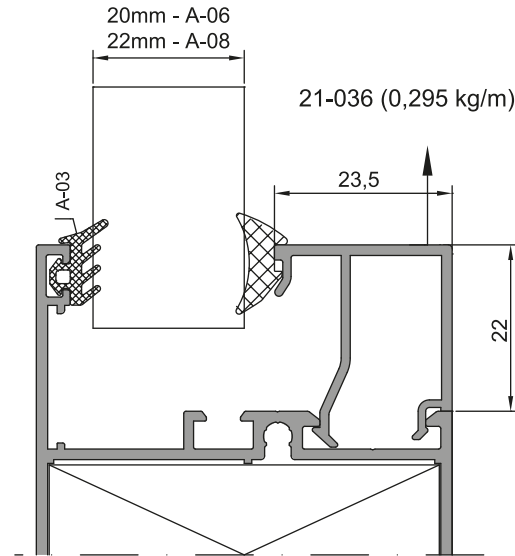

24mm - A-06
26mm - A-08

21-037 (0,278 kg/m)

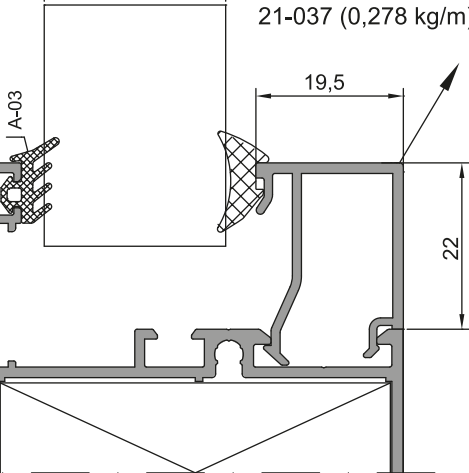

32mm - A-06
34mm - A-08

21-038 (0,247 kg/m)

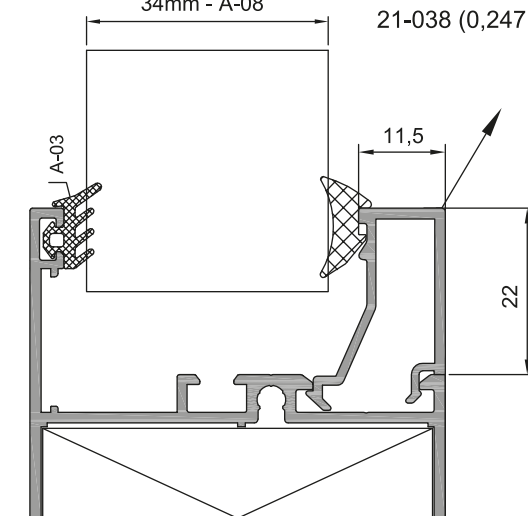

21-044 (3,030 kg/m)

Kullanılan Profil	Kesim Ölçüsü
Profile Used	Cutting Size
20 - 001	51,6 mm
20 - 005	
20 - 015	
20 - 007	53,9 mm

21-046 (4,157 kg/m)

Kullanılan Profil	Kesim Ölçüsü
Profile Used	Cutting Size
20 - 003	51,6 mm
20 - 006	
20 - 017	
20 - 010	53,7 mm
20 - 043	50,6 mm
20 - 047	50,6 mm

21-045 (3,566 kg/m)

Kullanılan Profil	Kesim Ölçüsü
Profile Used	Cutting Size
20 - 002	51,6 mm
20 - 016	
20 - 023	
20 - 024	
20 - 008	53,9 mm
20 - 026	
20 - 009	24,8 mm
20 - 044	52,9 mm

21-047 (3,220 kg/m)

Kullanılan Profil	Kesim Ölçüsü
Profile Used	Cutting Size
20 - 009	28,8 mm

20-039 (0,850 kg/m)

Kullanılan Profil	Kesim Ölçüsü
Profile Used	Cutting Size
20 - 015	13,7 MM
20 - 016	23,7 MM
20 - 017	33,7 MM
20 - 018	43,7 MM
20 - 019	73,7 MM
20 - 020	73,7 MM
20 - 023	23,7 MM
20 - 024	23,7 MM

21-048 (5,307 kg/m)

Kullanılan Profil	Kesim Ölçüsü
Profile Used	Cutting Size
20 - 004	51,4 mm
20 - 018	
20 - 021	43,4 mm
20 - 022	
20 - 011	53,7 mm
20 - 012	

21-050 (6,370 kg/m)

Kullanılan Profil	Kesim Ölçüsü
Profile Used	Cutting Size
20 - 013	53,5 mm
20 - 014	
20 - 045	52,9 mm
20 - 046	52,9 mm

20-048 (1,079 kg/m)

Kullanılan Profil	Kesim Ölçüsü
Profile Used	Cutting Size
20 - 002 20 - 016 20 - 023 20 - 024	51,6 mm
20 - 008 20 - 026	53,9 mm
20 - 009	24,8 mm
20 - 044	52,9 mm

20-051 (1,415 kg/m)

Kullanılan Profil	Kesim Ölçüsü
Profile Used	Cutting Size
20 - 013 20 - 014	53,5 mm
20 - 045	52,9 mm
20 - 046	52,9 mm

20-049 (1,176 kg/m)

Kullanılan Profil	Kesim Ölçüsü
Profile Used	Cutting Size
20 - 003 20 - 006 20 - 017	51,6 mm
20 - 010	53,7 mm
20 - 043	50,6 mm
20 - 047	50,6 mm

20-052 (0,948 kg/m)

Kullanılan Profil	Kesim Ölçüsü
Profile Used	Cutting Size
20 - 001 20 - 005 20 - 015	51,6 mm
20 - 007	53,9 mm

20-053 (1,016 kg/m)

Kullanılan Profil	Kesim Ölçüsü
Profile Used	Cutting Size
20 - 009	28,8 mm

20-050 (1,271 kg/m)

Kullanılan Profil	Kesim Ölçüsü
Profile Used	Cutting Size
20 - 004 20 - 018	51,4 mm
20 - 021 20 - 022	43,4 mm
20 - 011 20 - 012	53,7 mm

