

Alüminyum profiller AlMgSi 0,5 - F22 alaşımından ve 12020 standartlarına göre üretilir.

Fiziksel Özellikler :

1- Yoğunluk	: 2,71 gr /cm ³
2- Elastisite Modülü	: 70 kN /mm ²
3- Direnç	: 20° 33 n Ω .m
4- Erime Noktası	: 600 - 655 °
5 - Genleşme Katsayısı	: 20 - 100° Cμ °C ⁻¹

Mekanik Özellikler :

1- Elastisite Limiti	: 190 MPa
2 - Kopma Dayanıklılığı	: 220 MPa
3- Sertlik	: 67 Brinell
4- Uzama	: % 10

SİSTEM BİLGİLERİ:

Fiil (Conta): Tüm fitiller EPDM dir.

Yapılabilir Sürme tipleri: 2'li Sürme – 3'lü Sürme – 4'lü Sürme – 6'lı Sürme.



Kullanılabilir cam kalınlığı: 4 mm tek camdan 24 mm ısıcam kalınlığına kadar EPDM fitil kalınlıkları ve ölçüsüne uygun cam çitası ile ayarlanarak istenilen ısıcam ve tek cam kullanım imkanı sunmaktadır.







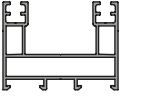
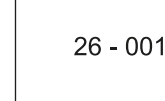
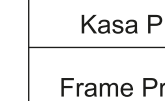
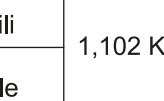
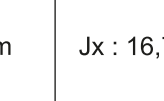
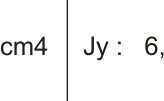
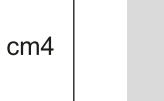

Su tahliye: Bütün profiller su tahliye sistemine sahiptir.

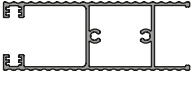
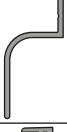

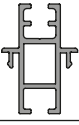
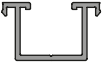

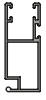

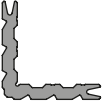

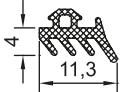
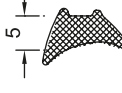
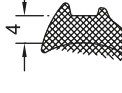
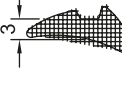
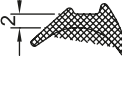

Ray: Alüminyum ve paslanmaz olarak alternatifli dizayn edilmiştir.





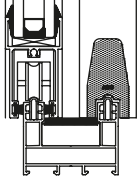





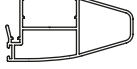

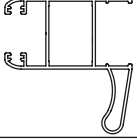
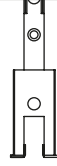
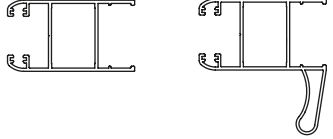
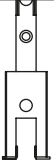
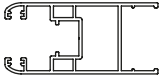

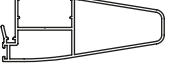

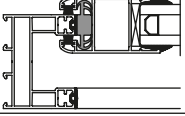
Aksesuar: Anahtarlı – anahtarsız gömme veya ispanyolet kol kullanılabilir.

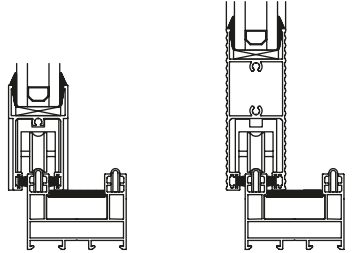

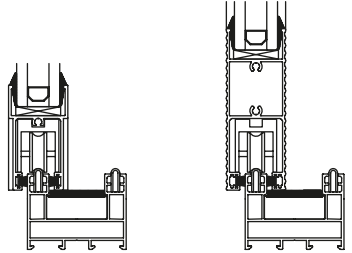

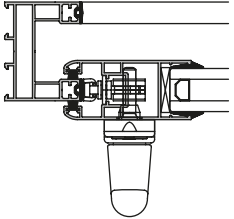

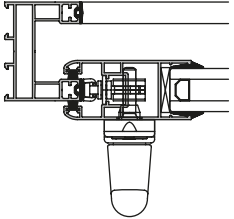

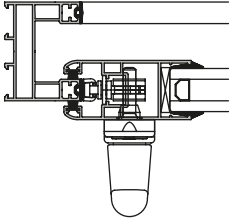
Bağlantılar: Kasa köşe birleşimlerini sağlamak için Pres Köşe Takoz Bağlantıları kullanılarak preslenir.

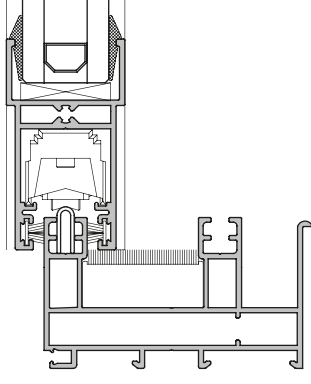

Profil Çizimleri Profile Drawing	Profil Kodu Profile Code	Profil Tanımı Profile Description	Profil Ağırlığı (Kg/m) Profile Weight (Kg/m)	Statik (Ix cm ⁴) Static (Iy cm ⁴)	Statik (Iy cm ⁴) Static (Ix cm ⁴)
	26 - 001	Kasa Profili	1,102 Kg/m	Jx : 16,72 cm ⁴	Jy : 6,27 cm ⁴
		Frame Profile			
	26 - 002	2'li Pervazlı Kasa Profili	1,350 Kg/m	Jx : 30,08 cm ⁴	Jy : 7,52 cm ⁴
		Double-rail frame profile with sill			
	26 - 003	3'lü Kasa Profili	1,763 Kg/m	Jx : 70,31 cm ⁴	Jy : 9,77 cm ⁴
		Triple-rail frame profile			
	26 - 004	Kasa Profili	0,565 Kg/m	Jx : 8,10 cm ⁴	Jy : 0,49 cm ⁴
		Frame Profile			
	26 - 005	Takviyeli Kanat Profili	1,053 Kg/m	Jx : 18,09 cm ⁴	Jy : 7,69 cm ⁴
		Structural sash profile			
	26 - 006	PVC İsp. Kanallı Kanat Profili	1,090 Kg/m	Jx : 7,01 cm ⁴	Jy : 14,70 cm ⁴
		PVC Sash Profile with Esp. Canal.			
	26 - 007	Kanat Profili	0,822 Kg/m	Jx : 5,55 cm ⁴	Jy : 8,44 cm ⁴
		Sash Profili			
	26 - 008	Orta Kanat Profili	0,648 Kg/m	Jx : 5,07 cm ⁴	Jy : 2,35 cm ⁴
		Middle Sash Profile			
	26 - 009	Takviyeli Orta Kanat Profili	0,934 Kg/m	Jx : 16,60 cm ⁴	Jy : 3,64 cm ⁴
		Structural sash profile			
	26 - 010	Takviyeli Orta Kanat Profili	1,085 Kg/m	Jx : 31,47 cm ⁴	Jy : 4,61 cm ⁴
		Structural sash profile			
	26 - 011	Etek Profili	0,735 Kg/m	Jx : 4,32 cm ⁴	Jy : 7,83 cm ⁴
		Bottom Profile			
	26 - 012	Etek Profili	0,864 Kg/m	Jx : 4,65 cm ⁴	Jy : 8,40 cm ⁴
		Bottom Profile			

Profil Çizimleri	Profil Kodu	Profil Tanımı	Profil Ağırlığı (Kg/m)	Statik (Ix cm4)	Statik (Iy cm4)
Profile Drawing	Profile Code	Profile Description	Profile Weight (Kg/m)	Static (Iy cm4)	Static (Ix cm4)
	26 - 013	Dekoratif Etek Profili Decorative Bottom Profile	1,167 Kg/m	Jx : 7,57 cm4	Jy : 29,90 cm4
	26 - 014	Damlalık Profili Offset Type Profile	0,195 Kg/m		
	26 - 015	Damlalık Profili Offset Type Profile	0,267 Kg/m		
	26 - 016	Ray Profili Rail Profile	0,125 Kg/m		
	26 - 017	Dörtlü Kanat Adaptörü Quartet Sash Adapter	0,413 Kg/m		
	26 - 018	Tek Cam Çıta Profili Single Glazing Bead Profile	0,270 Kg/m		
	05 - 001	U Profili U Profile	0,146 Kg/m		
	08 - 014	Çıta Profili Bead Profile	0,059 Kg/m		
	16 - 005	Sineklik Kanat Profili Fly Screen Sash Profile	0,419 Kg/m		
	16 - 010	Sineklik Ray Profili Fly Screen Rail Profile	0,261 Kg/m		
	22 - 065	Kasa Köşe Takoğu Frame Corner Block	1,958 Kg/m		
	21 - 047	Kasa Köşe Takoğu Frame Corner Block	3,220 Kg/m		

Profil Çizimleri Profile Drawing	Profil Kodu Profile Code	Profil Tanımı Profile Description	Profil Ağırlığı (Kg/m) Profile Weight (Kg/m)		
	A - 03	Dış Cam Fitolu Outer Glazing Gasket	0,041 Kg/m		
	A - 05	Çıta Fitolu Bead Gasket	0,061 Kg/m		
	A - 06	Çıta Fitolu Bead Gasket	0,073 Kg/m		
	A - 07	Çıta Fitolu Inner Glazing Gasket	0,061 Kg/m		
	A - 08	Çıta Fitolu Inner Glazing Gasket	0,047 Kg/m		
	A - 22	Kasa Fitolu Fixing Gasket	0,027 Kg/m		
	A - 26	Kasa Fitolu Frame Gasket	0,031 Kg/m		
	A - 27	Kasa Fitolu Frame Gasket	0,013 Kg/m		
	A - 55S -01	Sürme Kanat Kıl Fitolu Finli (69x700) Sash Brush Seal			
	A - 55S -02	Sineklik Kanat Kıl Fitolu Finli (67x200) Fly screen Sash Brush Seal			
	A - 55S -03	Orta Kanat Dış Kapağı Mid. Sash Profile Outer Cover			  
	A - 55S -04	Orta Kanat İç Kapağı Mid. Sash Profile Inner Cover			

Şekli Drawing	Kodu Code	Adı Name	Profil Kullanımı Profile Used
	A - 55S -05	26-009 Sash Cover	
		26-009 Kanat Kapağı	
	A - 55S -06	26-005 Sash Cover	
		26-005 Kanat Kapağı	
	A - 55S -07	26-005 / 007 Sash Cover	
		26-005 / 007 Kanat Kapağı	
	A - 55S -08	26-006 Sash Cover	
		26-006 Kanat Kapağı	
	A - 55S -09	26-010 Sash Cover	
		26-010 Kanat Kapağı	
	A - 55S -10	Stoper	
	A - 55S -11	Tozluk	
		Striker	
	A - 55S -12	Paslanmaz Ray	
		Stainless Rail	
	A - 55S -13	Rulman	
		Roller	
	A - 55S -14	İspanyolet Kol	
		Espagnolette Handle	
	A - 55S -15	Karşılık	
		Centre Seal	
	A - 55S -16-00	İspanyolet	
		Espagnolette	

Şekli Drawing	Kodu Code	Adı Name	Profil Kullanımı Profile Used
	G - 55S -01	Rulman	
		Roller (bearing)	
	G - 55S -02	Anahtarlı Gömme Kol	
		Hidden Handle With Key	
	G - 55S -03	Anahtarsız Gömme Kol	
		Hidden Handle Without Key	
	G - 55S -04	Gömme Tutamak	
		Centre Seal	
	G - 55S -05	Havuz Kilit Karşılığı	
		Hidden Handgrip	
	G - 55S -06	Havuz Kilit Dili	
		Latch	
	A - 55S -17	Sineklik Fiteli	
		Flyscreen Gasket	
	A - 55S -18	Sineklik Teli	
		Fly Screen Wire Mesh	
	A - 55S -19	Sineklik Köşe Takoğu	
		Fly Screen Wire Mesh	

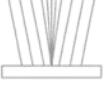
Şekli	Kodu	Adı		
	A - 55S -20	Sineklik Rulmanı		
	A - 55S -21	Su Tahliye Kapağı		
	A - 55S -22			
	A-55S-23	Sineklik Kanat Kıl Fitol (67x700)		

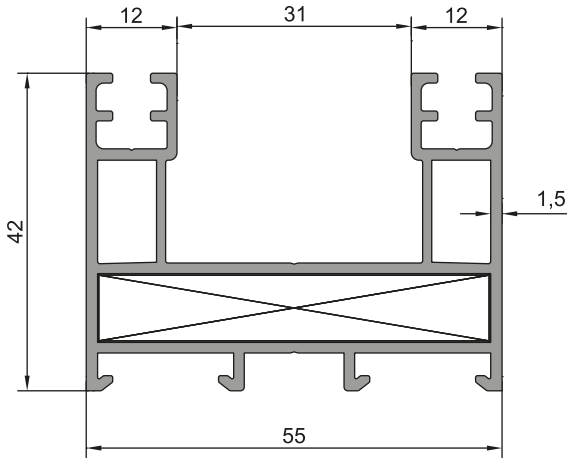

KASA PROFİLİ
26-001 (1,102 kg/m)
Jx: 16,72 cm⁴ / Jy: 6,27 cm⁴

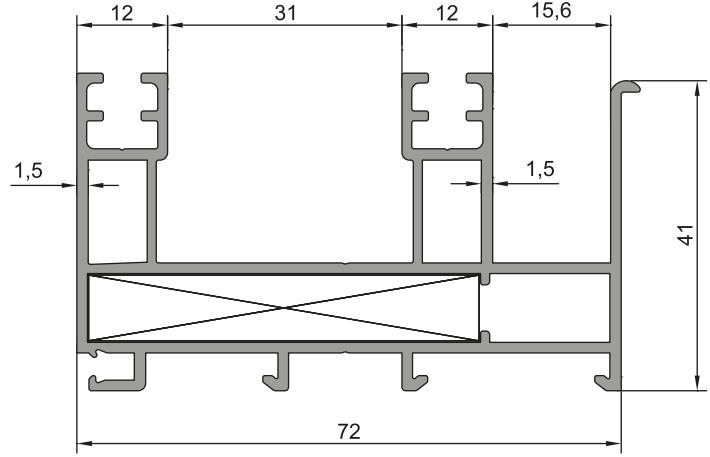

2'Lİ PERVAZLI KASA PROFİLİ
26-002 (1,350 kg/m)
Jx: 30,08 cm⁴ / Jy: 7,52 cm⁴

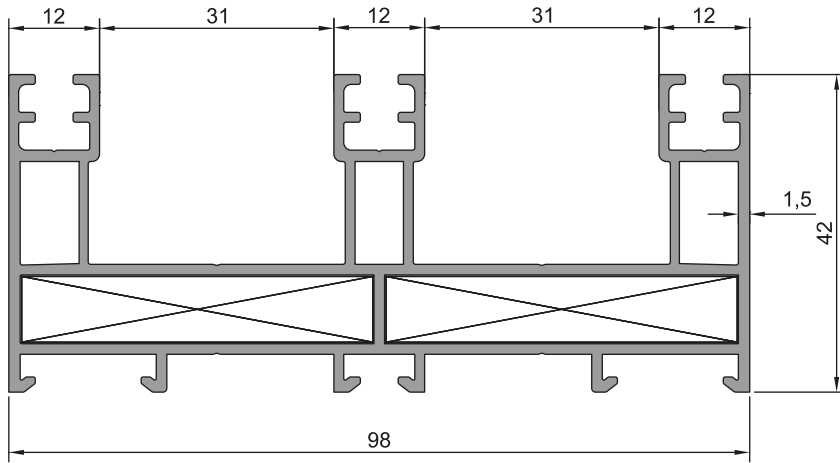

3'LÜ KASA PROFİLİ
26-003 (1,763 kg/m)
Jx: 70,31 cm⁴ / Jy: 9,77 cm⁴

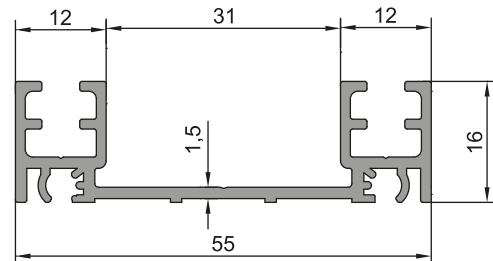

KASA PROFİLİ
26-004 (0,565 kg/m)
Jx: 8,10 cm⁴ / Jy: 0,49 cm⁴

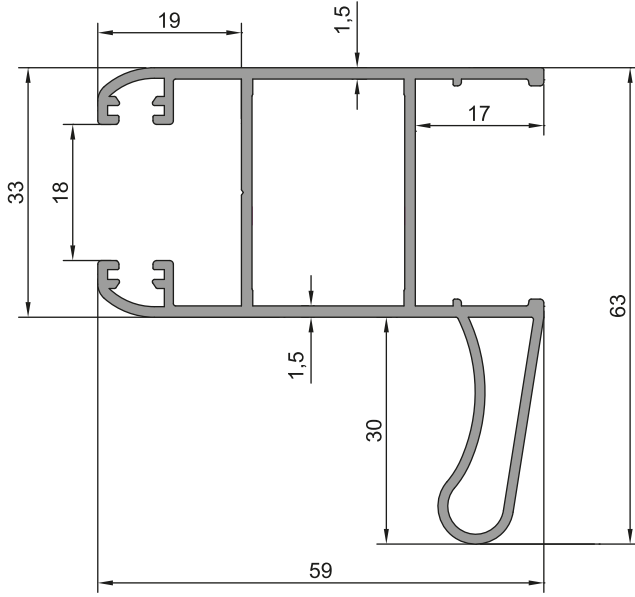

TAKVİYELİ KANAT PROFİLİ
26-005 (1,053kg/m)
Jx: 18,09 cm⁴ / Jy: 7,69 cm⁴

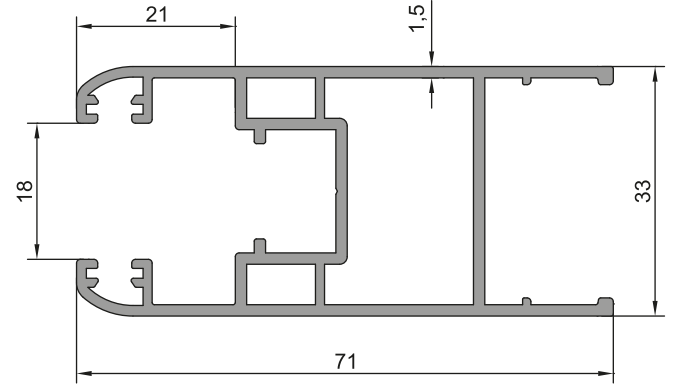

PVC İSP. KANALLI KANAT PROFİLİ
26-006 (1,090kg/m)
Jx: 7,01 cm⁴ / Jy: 14,70 cm⁴

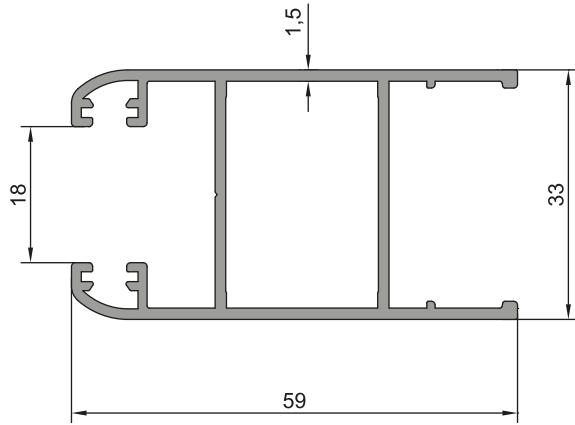

KANAT PROFİLİ
26-007 (0,822kg/m)
Jx: 5,55 cm⁴ / Jy: 8,44 cm⁴

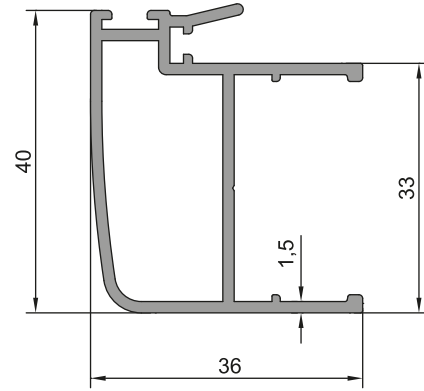

ORTA KANAT PROFİLİ
26-008 (0,648kg/m)
Jx: 5,07 cm⁴ / Jy: 2,35 cm⁴

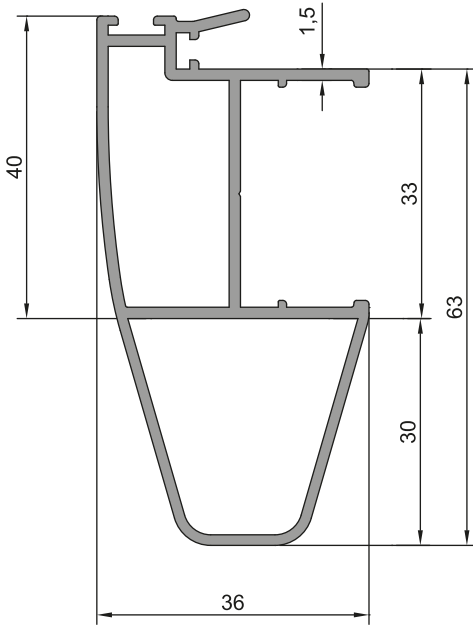

TAKVİYELİ ORTA KANAT PROFİLİ
26-009 (0,934kg/m)
Jx: 16,60 cm⁴ / Jy: 3,64 cm⁴

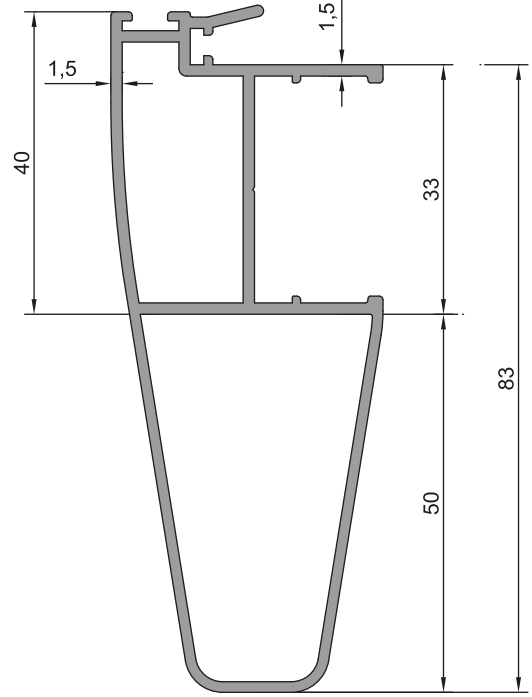

TAKVİYELİ ORTA KANAT PROFİLİ
26-010 (1,085kg/m)
Jx: 31,47 cm⁴ / Jy: 4,61 cm⁴

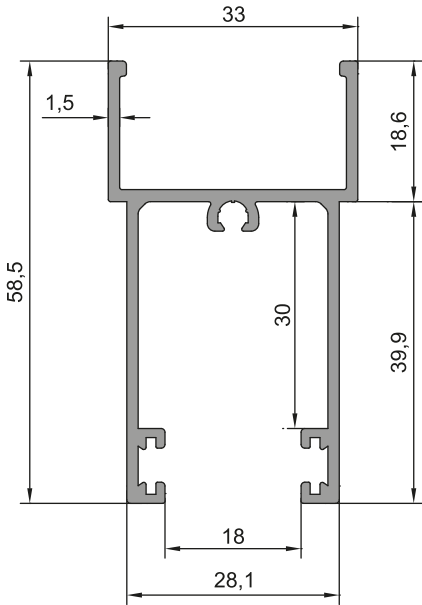

ETEK PROFİLİ
26-011 (0,735kg/m)
Jx: 4,32 cm⁴ / Jy: 7,83 cm⁴

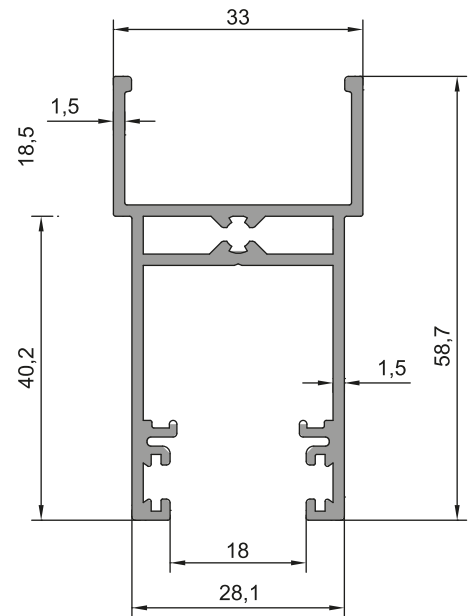

ETEK PROFİLİ
26-012 (0,864kg/m)
Jx: 4,65 cm⁴ / Jy: 8,40 cm⁴

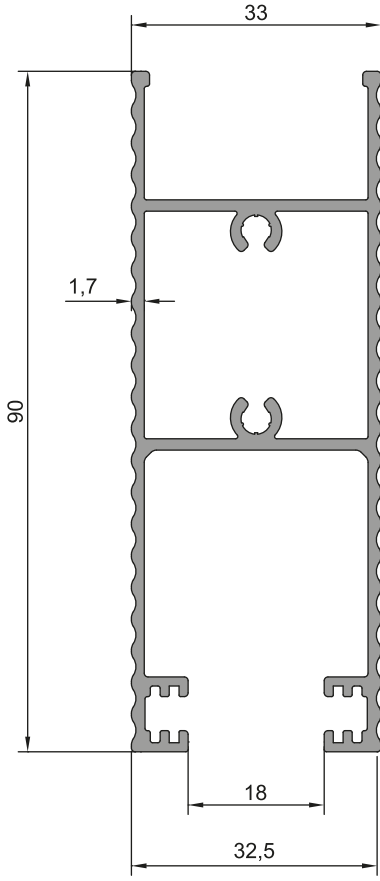

DEKORATİF ETEK PROFİLİ
26-013 (1,167kg/m)
Jx: 7,57 cm⁴ / Jy: 29,90 cm⁴

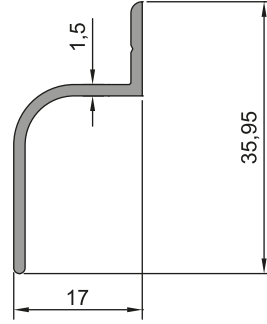

DAMLALIK PROFİLİ
26-014 (0,195kg/m)

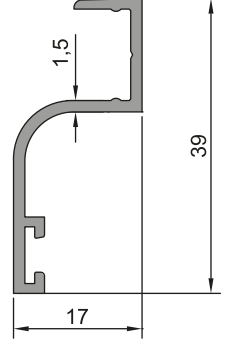

DAMLALIK PROFİLİ
26-015 (0,267kg/m)

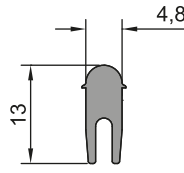

RAY PROFİLİ
26-016 (0,125kg/m)

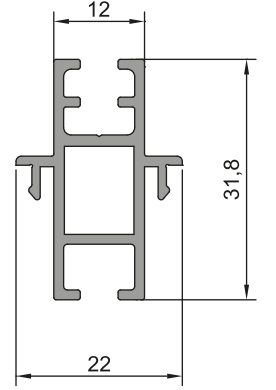

DÖRTLÜ KANAT ADAPTÖRÜ
26-017 (0,413kg/m)

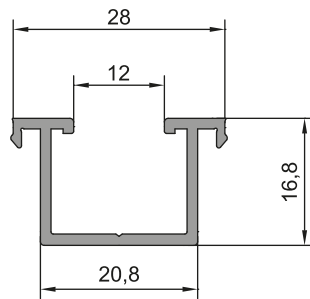

TEK CAM ÇITA PROFİLİ
26-018 (0,270kg/m)

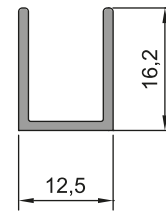

U PROFİLİ
05-001 (0,146kg/m)

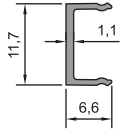

ÇITA PROFİLİ
26-014 (0,059kg/m)

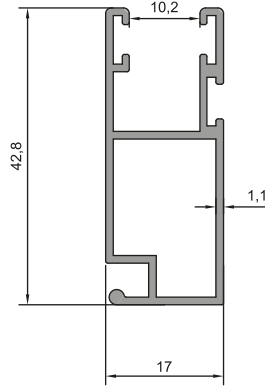

SİNEKLİK KANAT PROFİLİ
16-005 (0,419kg/m)

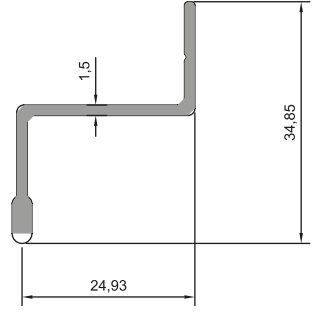

SİNEKLİK RAY PROFİLİ
16-010 (0,261kg/m)

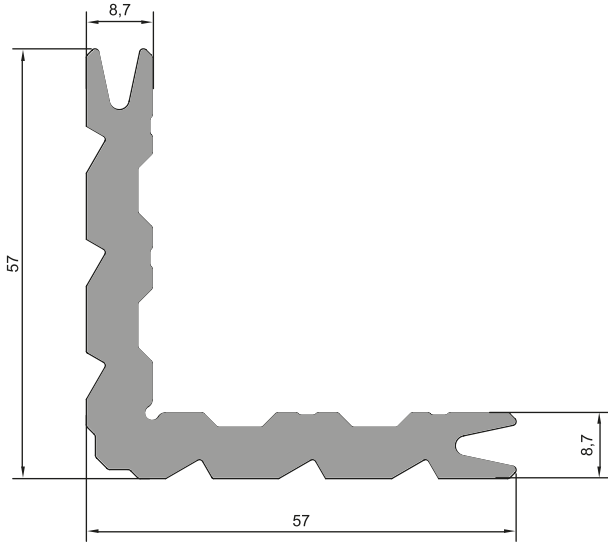

KÖŞE TAKOZU
22-065 (1,958kg/m)

Kullanılan Profil	Kesim Ölçüsü
Profile Used	Cutting Size
26 - 001 26 - 002	51,7 mm
26 - 003	46,5 mm

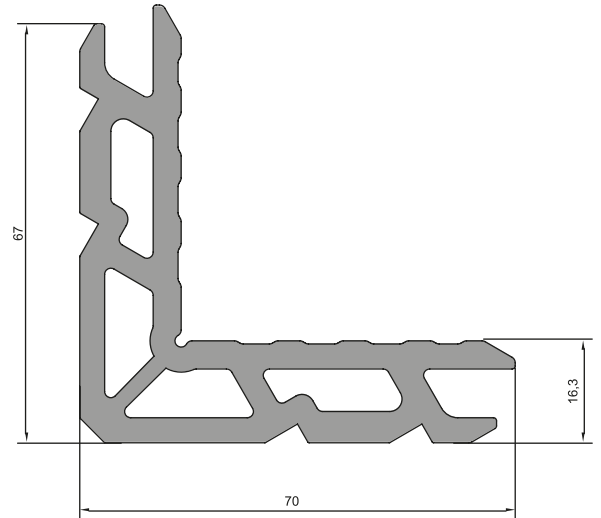
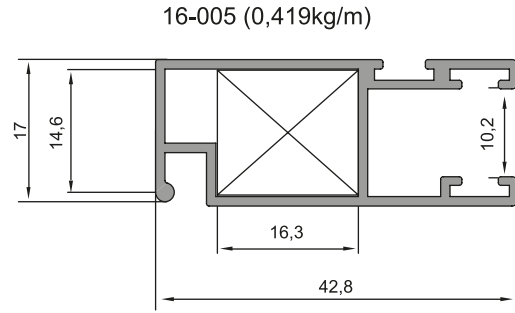

KÖŞE TAKOZU
21-047 (3,220kg/m)

Kullanılan Profil	Kesim Ölçüsü
Profile Used	Cutting Size
16 - 005	14,6 mm

