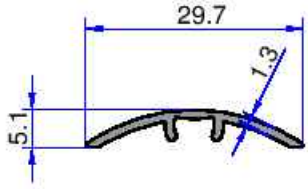
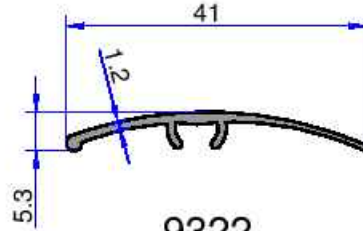
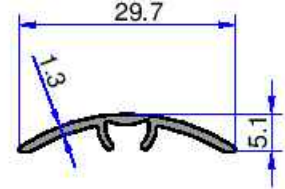
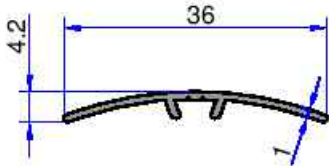
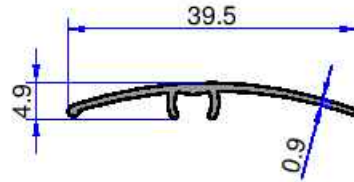
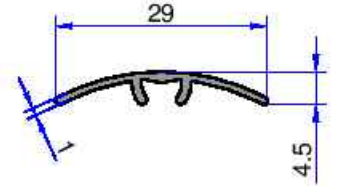
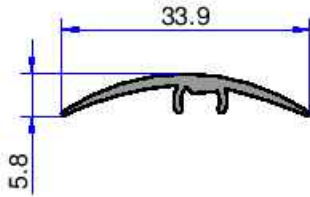
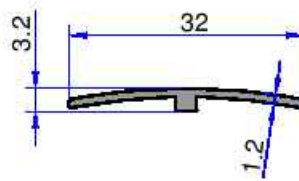
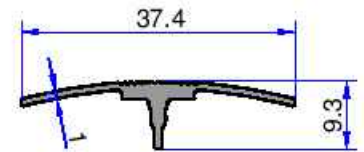
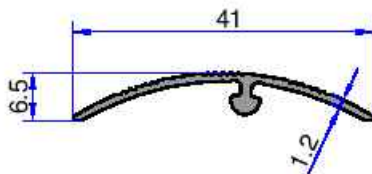
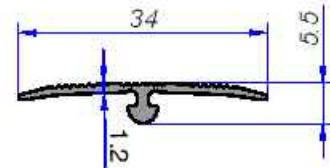

AKALDO

Alüminyum Sanayi Tic. A.Ş.

HALI BASAMAK VE LAMİNAT PARKE PROFİLLERİ

**web: www.akaldo.com
email: pazarlama@akaldo.com**

**9427**
0.121 kg/m**9322**
0.156 kg/m**10536**
0.124 kg/m**5191**
0.117 kg/m**10108**
0.138 kg/m**5381**
0.107 kg/m**4721**
0.154 kg/m**5267**
0.120 kg/m**6124**
0.168 kg/m**10-2722**
0.157 kg/m**10-2723**
0.127 kg/m

HALI BASAMAK VE LAMİNAT PARKE PROFİLLERİ

AKALDO
Alüminyum Sanayi Tic. A.Ş.

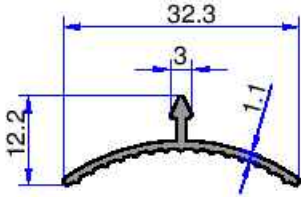

5305
0.137 kg/m

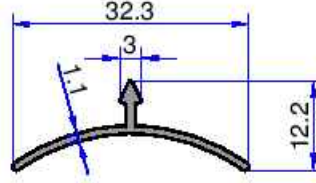

5306
0.127 kg/m

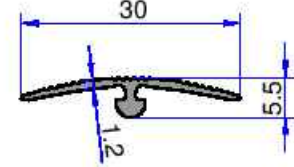

10-2716
0.114 kg/m

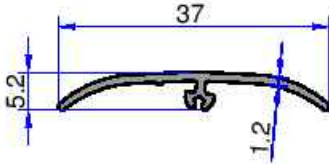

9929
0.147 kg/m

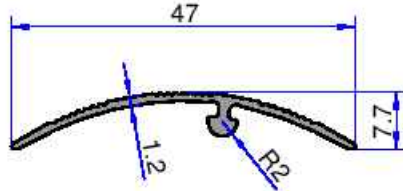

10-2721
0.176 kg/m

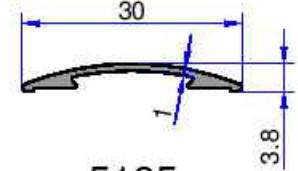

5185
0.105 kg/m

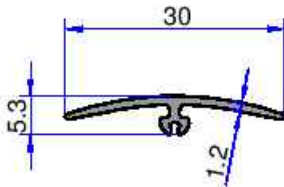

4999
0.116 kg/m

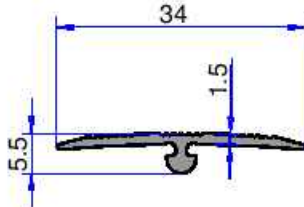

10-2710
0.148 kg/m

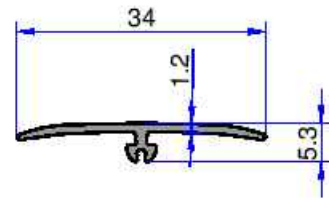

5000
0.130 kg/m

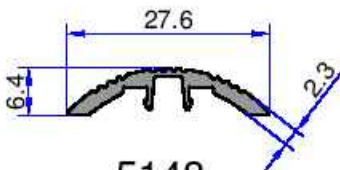

5148
0.157 kg/m

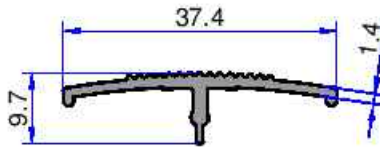

5088
0.207 kg/m

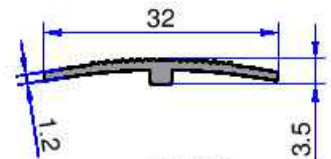

5089
0.128 kg/m

Not: Katalog ağırlıklar teorik ağırlıklardır. Üzerine kalıp aşınmasından dolayı %3-%5 boya farkından dolayı %4-%6 ağırlık ilave edilecektir.

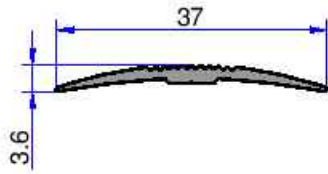

6505
0.147 kg/m

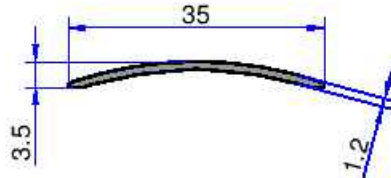

5400
0.106 kg/m

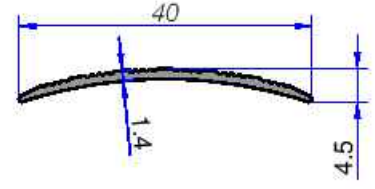

10-2702
0.138 kg/m

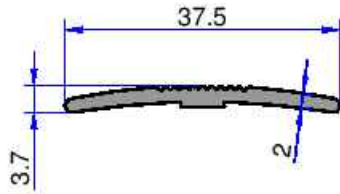

5284
0.215 kg/m

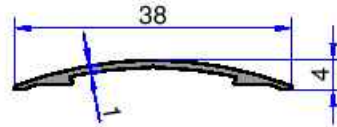

9806
0.111 kg/m

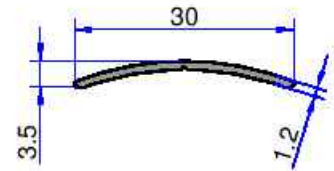

5181
0.092 kg/m

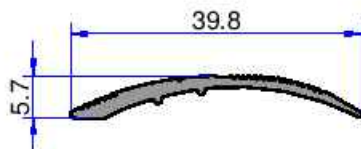

10167
0.190 kg/m

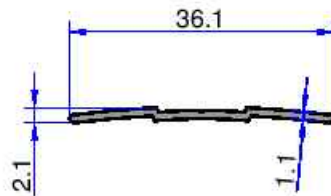

5433
0.109 kg/m

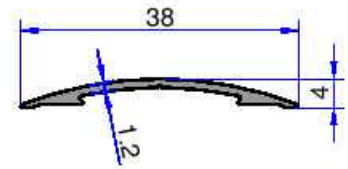

5184
0.132 kg/m

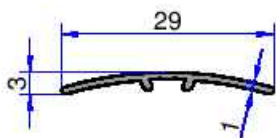

5530
0.087 kg/m

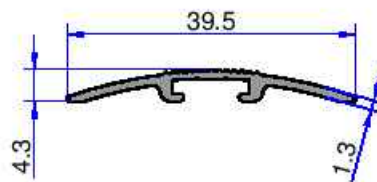

5104
0.160 kg/m

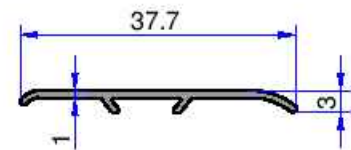

1706
0.117 kg/m

HALI BASAMAK VE LAMİNAT PARKE PROFİLLERİ

AKALDO
Alüminyum Sanayi Tic. A.Ş.

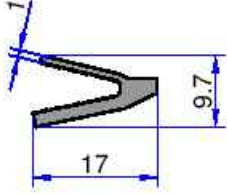

3877
0.135 kg/m

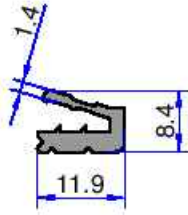

3928
0.133 kg/m

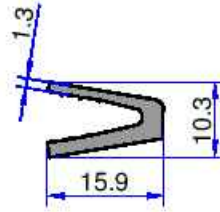

3876
0.169 kg/m

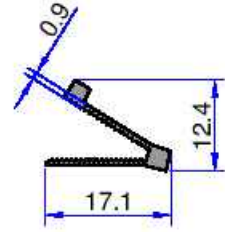

3852
0.089 kg/m

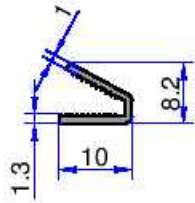

3853
0.043 kg/m

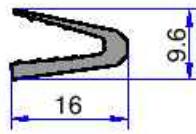

3875
0.134 kg/m

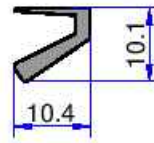

3866
0.100 kg/m

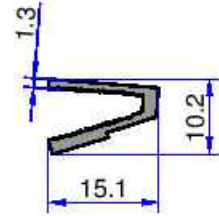

3867
0.120 kg/m

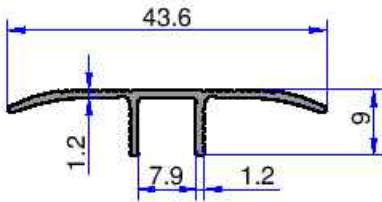

10-2715
0.175 kg/m

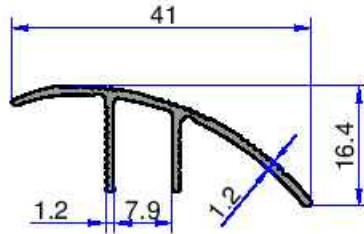

10-2714
0.202 kg/m

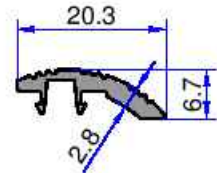

5149
0.134 kg/m

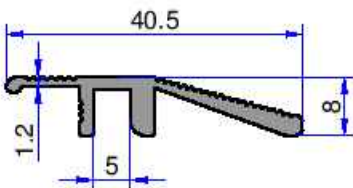

5282
0.286 kg/m

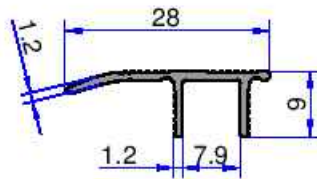

10-2713
0.127 kg/m

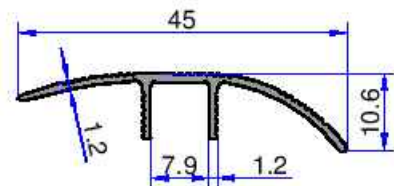

10-2712
0.186 kg/m

Not: Katalog ağırlıkları teorik ağırlıklardır. Üzerine kalıp aşınmasından dolayı %3-%5 boya farkından dolayı %4-%6 ağırlık ilave edilecektir.

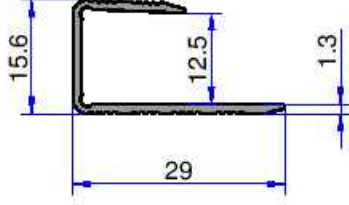
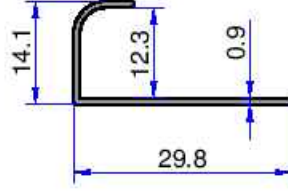
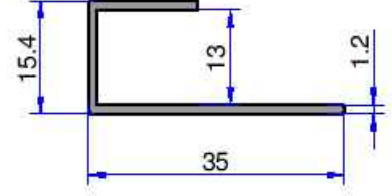
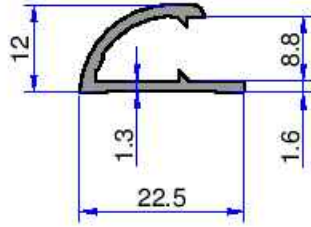
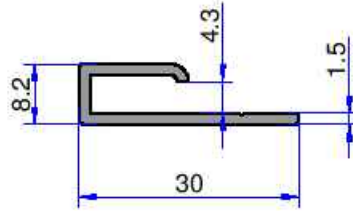
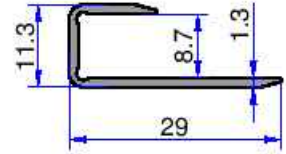
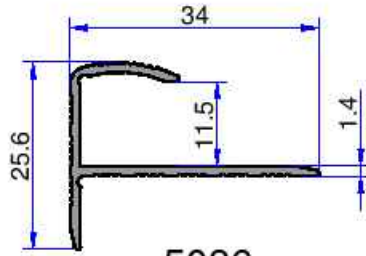
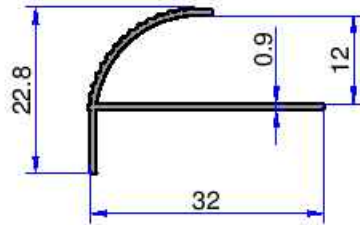
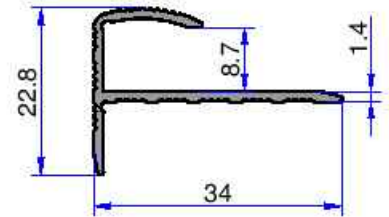
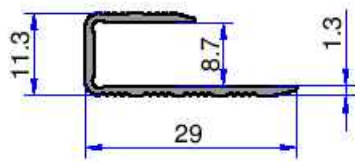
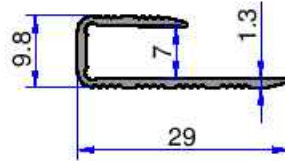
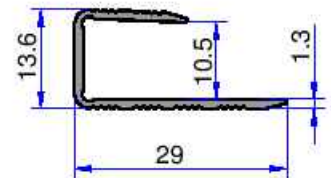
**10-2726**
0.177 kg/m**6125**
0.118 kg/m**7351**
0.204 kg/m**3883**
0.181 kg/m**4983**
0.203 kg/m**4712**
0.160 kg/m**5086**
0.240 kg/m**6126**
0.160 kg/m**10-2708**
0.230 kg/m**10-2707**
0.161 kg/m**10-2703**
0.156 kg/m**10-2724**
0.170 kg/m

HALI BASAMAK VE LAMİNAT PARKE PROFİLLERİ

AKALDO

Alüminyum Sanayi Tic. A.Ş.

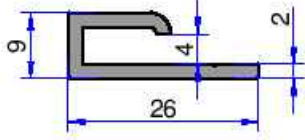

5559
0.244 kg/m

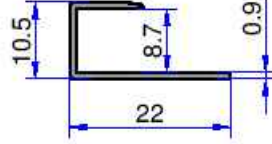

5285
0.097 kg/m

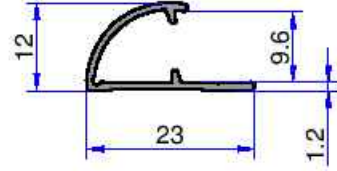

5595
0.122 kg/m

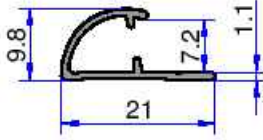

5575
0.107 kg/m

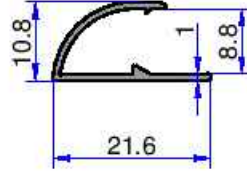

5320
0.115 kg/m

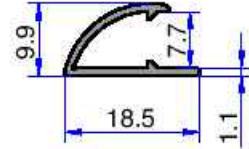

5321
0.110 kg/m

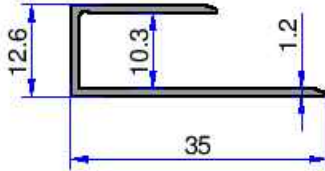

9007
0.204 kg/m

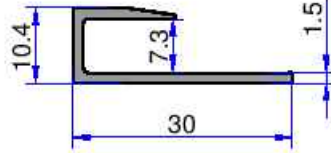

6428
0.201 kg/m

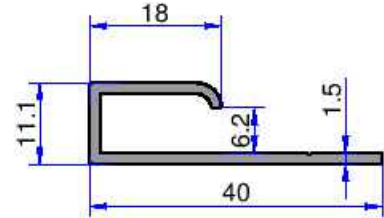

11027
0.271 kg/m

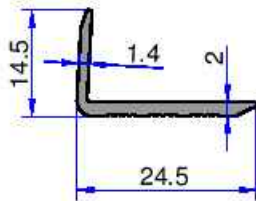

10-2736
0.164 kg/m

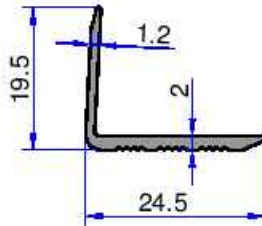

10-2709
0.174 kg/m

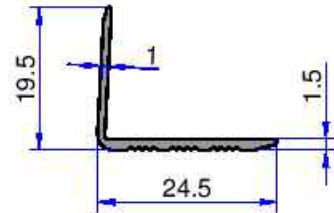

10-2718
0.136 kg/m

Not: Katalog ağırlıkları teorik ağırlıklardır. Üzerine kalıp aşınmasından dolayı %3-%5 boya farkından dolayı %4-%6 ağırlık ilave edilecektir.

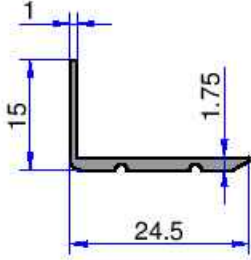

5085
0.142 kg/m

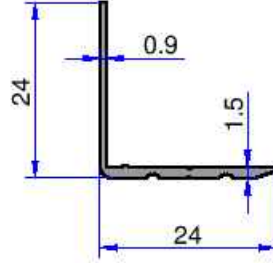

5188
0.143 kg/m

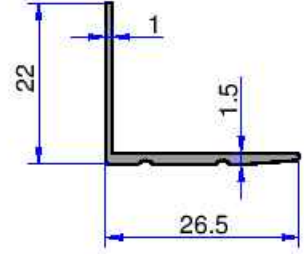

4995
0.153 kg/m

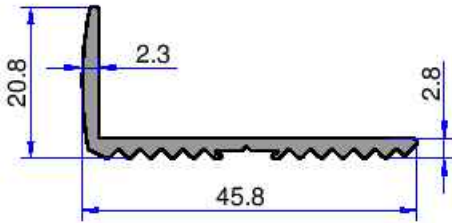

5087
0.344 kg/m

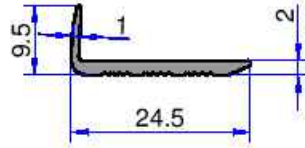

10-2704
0.138 kg/m

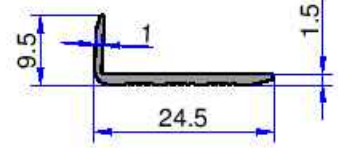

10-2717
0.109 kg/m

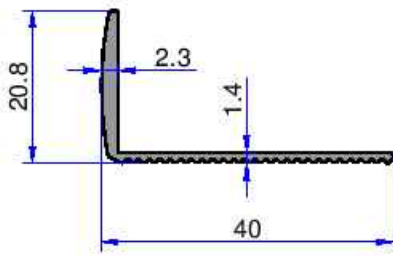

5268
0.224 kg/m

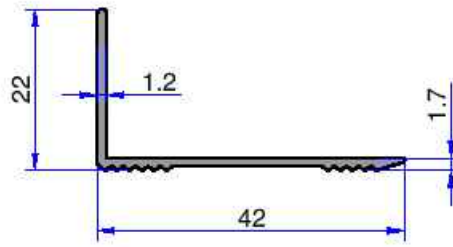

5192
0.209 kg/m

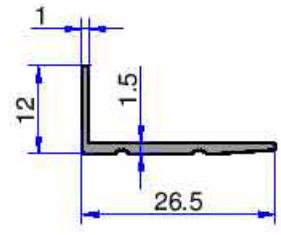

4996
0.126 kg/m

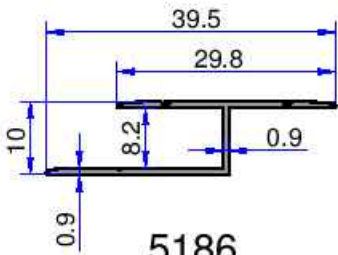

5186
0.148 kg/m

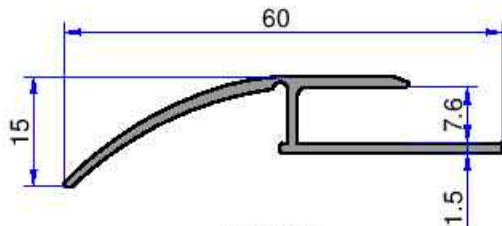

5888
0.347 kg/m

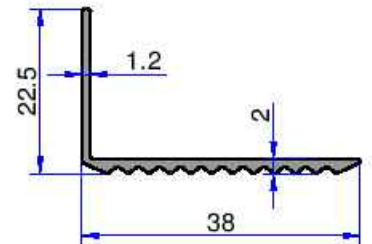

9068
0.218 kg/m

HALI BASAMAK VE LAMİNAT PARKE PROFİLLERİ

AKALDO
Alüminyum Sanayi Tic. A.Ş.

Not: Katalog ağırlıklar teorik ağırlıklardır. Üzerine kalıp aşınmasından dolayı %3-%5 boya farkından dolayı %4-%6 ağırlık ilave edilecektir.

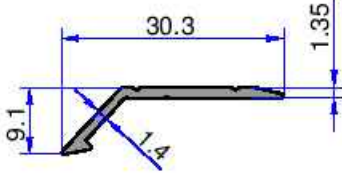

5216
0.119 kg/m

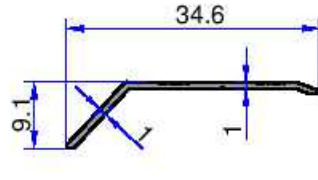

6324
0.097 kg/m

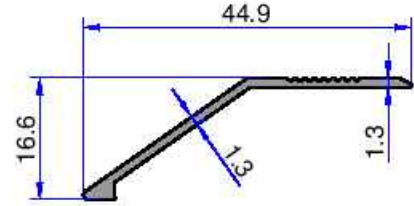

5193
0.177 kg/m

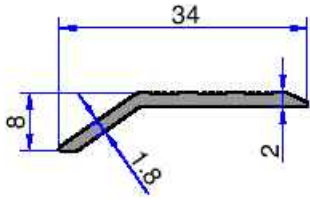

10-2734
0.173 kg/m

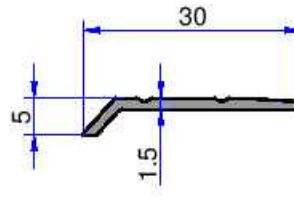

4997
0.116 kg/m

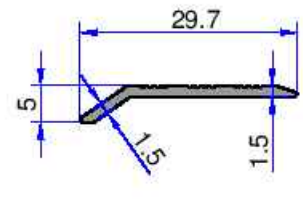

10-2719
0.113 kg/m

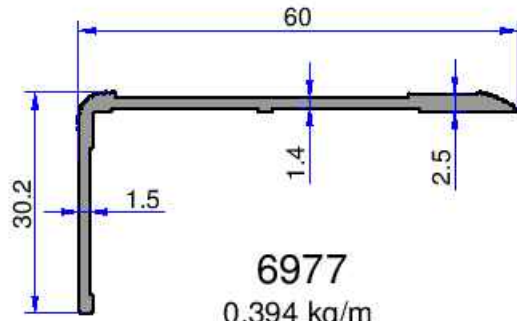

6977
0.394 kg/m

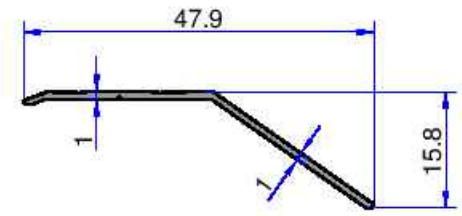

6323
0.137 kg/m

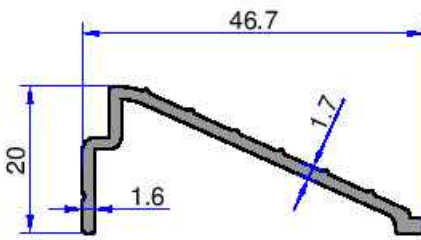

11163
0.321 kg/m

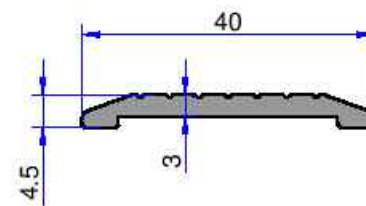

4201
0.312 kg/m

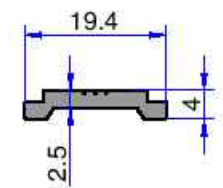

4113
0.136 kg/m

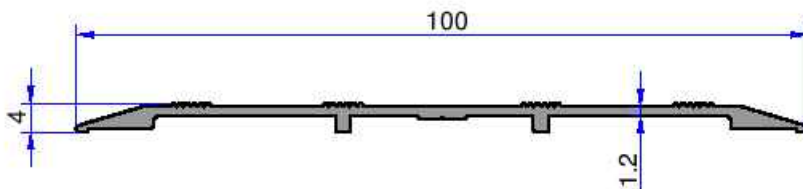
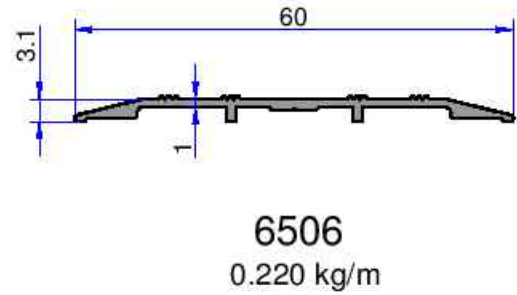
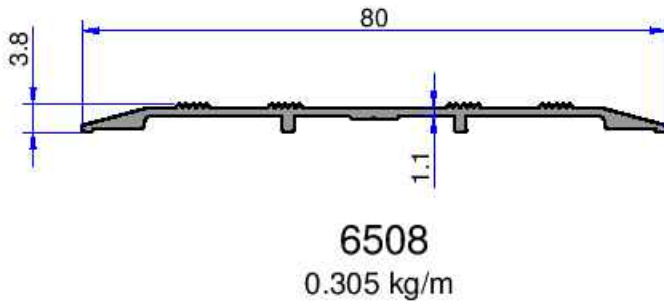
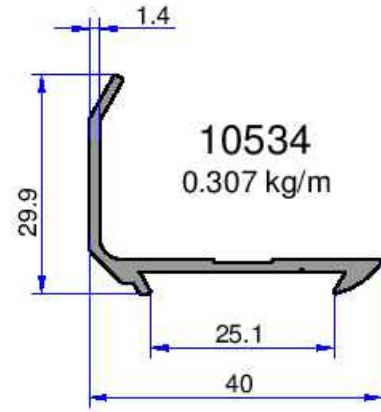
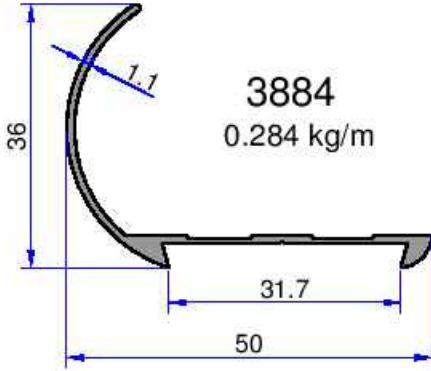
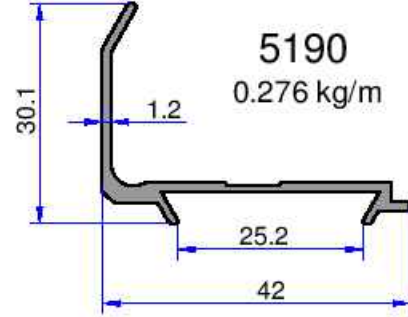
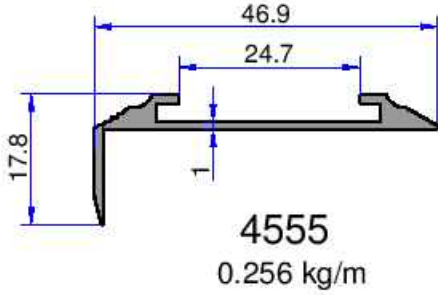

HALI BASAMAK VE LAMİNAT PARKE PROFİLLERİ

AKALDO
Alüminyum Sanayi Tic. A.Ş.

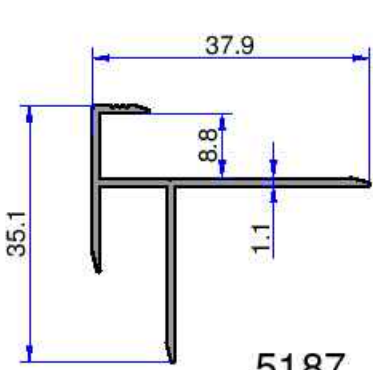

5187
0.259 kg/m

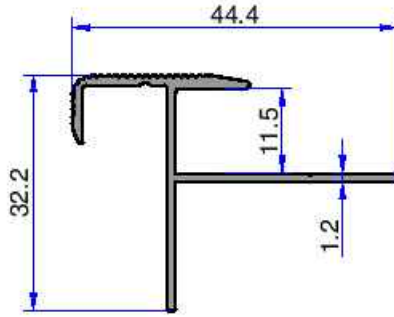

5090
0.312 kg/m

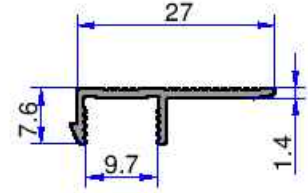

10-2730
0.127 kg/m

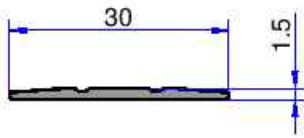

4998
0.106 kg/m

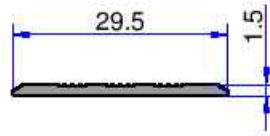

10-2720
0.111 kg/m

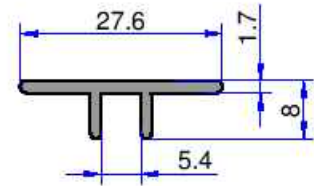

3235
0.173 kg/m

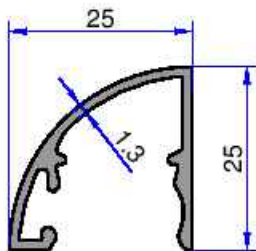

10448
0.291 kg/m

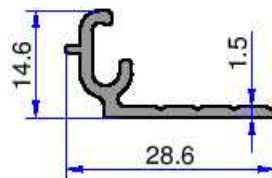

10919
0.199 kg/m

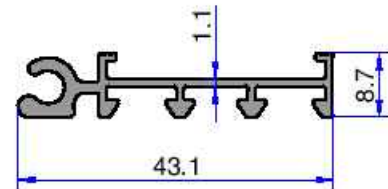

10920
0.312 kg/m

Not: Katalog ağırlıkları teorik ağırlıklardır. Üzerine kalıp aşınmasından dolayı %3-%5 boya farkından dolayı %4-%6 ağırlık ilave edilecektir.

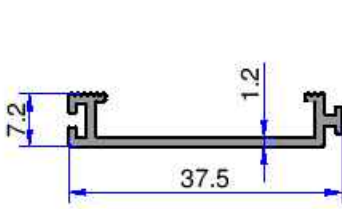
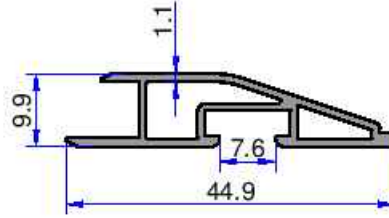
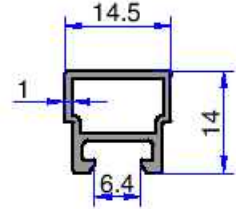
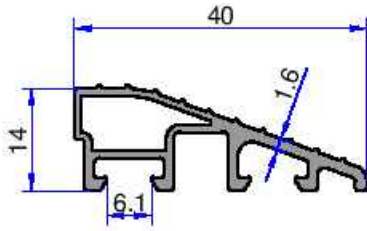
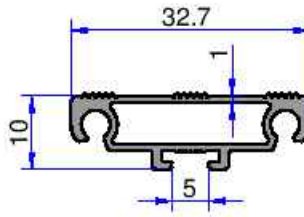
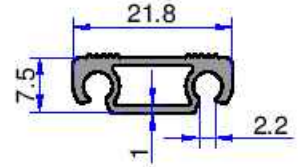
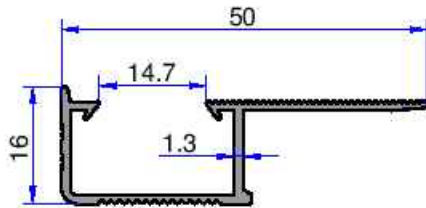
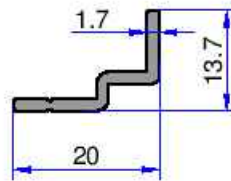
**10986**
0.194 kg/m**10987**
0.313 kg/m**11051**
0.163 kg/m**11050**
0.351 kg/m**5380**
0.272 kg/m**5379**
0.190 kg/m**5169**
0.279 kg/m**11162**
0.137 kg/m